

Product No. **8221-200-12**
 S No. **4212206**
 EAN No. **7312908221122**



Opus 100/125

Opus 100/125 is an elegant, cylindrical shaped light fitting. Its timeless design is suitable for wall or ceiling installation, both indoors and outdoors.

Specification

Base material	Porcelain
Lampholder	G9
Light source	Max 40W (not incl.)
Voltage	230V
Installation	Ceiling/wall
Base colour	Grey NCS S 6005-G50Y
Safety class	II
Protection class	IP44
Energy class	-
T _a	-30 - +25
Height	125 mm
Diameter Ø	97 mm
Glass	Matt opal
Thread	84,5 mm
Weight	0,77 kg
Design	Duoform

Installation

Insert the mains supply cable through the bottom inlet. Fix the light fitting to the wall or to the ceiling with suitable screws. Connect the leads to mantle screws. Fasten the lamp holder. Insert a light source and then fasten the shade by turning it clockwise. Make sure the gasket between the glass and base is in place.

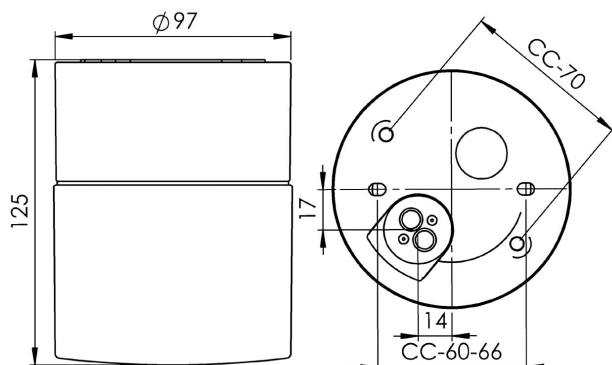

Technical information

Silicone gasket between glass and base. Four Ø 5mm holes for installation. Two holes CC measurement 60-66 mm, alternatively two hidden holes CC measurement 70 mm. One bottom inlet for two mains supply cable. Two mantle screws for connection of max 2 x 2,5 mm². Bridging is possible. Bottom inlet. No knock out openings.

Maintenance

Switch off the power to the fixture. Remove the shade and clean it. Do not use cleaning agents containing solvents. Change the light source if necessary. Check the gasket and change it if necessary. Replace the shade.

Spare parts

Shade: Part no 1-6181-30
 Gasket: Part no 02786-1

If the luminaire is modified the person responsible for the modification shall be considered manufacturer. Subject to errors in text. We reserve the right to change the technical specifications (without notice).